

Environmental Assessment of Al-Hilla City Wastewater Treatment Plants

Mohammad A. Alanbari¹, Hind Q. Alazzawi¹, Nadhir A. Al-Ansari² and Sven Knutsson²

1. College of Engineering, Babylon University, Babylon, Iraq

2. Department of Civil, Environmental and Natural Resources Engineering, Lulea University of Technology, Lulea 97187, Sweden

Abstract: Iraq is one of the countries that is suffering from water shortage problems and, for this reason, wastewater treatment plants become a necessity to minimize this problem. In this study, the impact of Al-Hilla WWTP (wastewater treatment plant) on the environment has been studied. This was achieved using SimaPro software package. This software is a powerful tool for analyzing the environmental impact on products during their whole life cycle. A huge amount of knowledge about the environment is built into the program and database, enabling to analyze a product with a minimum of specialized knowledge. The results of LCA (life cycle assessment) showed that the impact and damage on the environment by Al-Hilla WWTP was 41 bad points for each 1 m³ of treated wastewater. The most environmental impacts potentially were global warming, respiratory inorganics and non-renewable energy. The study also showed that most of the effects were the result of the use of cement, steel and electricity consumption.

Key words: SimaPro, environmental impact, life cycle assessment, wastewater treatment plant, Al-Hilla.

1. Introduction

Iraq is located in the eastern part of the MENA (Middle East and North African) countries. This country is facing serious water shortage problem. This problem is expected to be more severe in the future where the supply will be 43 BCM (billion cubic meters) and 17.61 BCM in 2015 and 2025, respectively, while the current demand is estimated between 66.8 BCM to 77 BCM [1-5]. In addition to all this, it has been reported that Tigris and Euphrates discharges will continue to decrease with time, and they will be completely dry by 2040 [1-5]. In view of this situation, wastewater treatment plants were installed to use the treated water to minimize the gap between water supply and demand.

Wastewater treatment can be divided into two main steps: the water line and the sludge line. The water line is structured into the pre-treatment, primary treatment, secondary treatment (biologic reactor and secondary

reactor) and tertiary treatment (sand filtration, UV (ultraviolet) treatment and chlorination) [6]. LCA (life cycle assessment) is a standard international tool, ISO (International Standardization Organization) 14040, used to evaluate the environmental impact of products, processes and services. It takes into consideration the entire life cycle, from raw material extraction, manufacturing, distribution, use, end of life treatment, recycling and eventually disposal [1]. LCA is described in the ISO 14040:1997 series, namely by ISO 14041:1997 standard—Definition of Objective, Scope and Inventory Analysis, ISO14042:1997 standard—Environmental Impact Assessment and ISO 14043:1997 standard—Interpretation [7]. SimaPro 7 software was used for the inventory and database on resources consumption and environmental emissions in the present LCA [8].

In this study, Al-Hilla WWTP (wastewater treatment plant) was taken as a case study to be environmentally assessed.

Corresponding author: Nadhir A. Al-Ansari, professor, research fields: water resources and environmental engineering. E-mail: nadhir.alansari@ltu.se.

2. Methodology

2.1 Wastewater Treatment Plant

Al-Hilla City covers an area of 5,603 km², with an estimated population of 1,846,326 people in 2011 [9]. The case study was Al-Hilla WWTP (extended aeration lagoons). This plant is located in Babylon Governorate, Iraq (Fig. 1). It was constructed in 1977, located about 6 km south of Al-Hilla City with design capacity 12,000 m³/day.

The treatment plant consists of the following units (as shown in Fig. 2):

- (1) screens: to separate the coarse floating substances;
- (2) lift pumping station: four pumps of 55 kW each;
- (3) grit chamber: to settle the grit and inorganic suspended solids;
- (4) storing tank;
- (5) parshall flume;
- (6) flow distribution chamber;
- (7) aeration tanks: the biological treatment is conducted by the means of activated sludge process with two aeration lagoons, each one (70 × 46.5 × 3 m³), with six surface aerators, three along each side with angular velocity of 32 rpm, with power of 37.5 kW;
- (8) flow distribution chamber;
- (9) secondary settling tanks: two tanks, each one 32 m in diameter and 2 m in depth;
- (10) collection chamber;
- (11) parshall flume;
- (12) chlorination unit;
- (13) outlet at Shatt Al-Hilla about 5 km away from treatment plant;
- (14) sludge pumping station: two pumps of 45 kW and three pumps of 15 kW and other three pumps of 22 kW for each one;
- (15) sludge collection tanks: two aerated tanks;
- (16) drying beds.

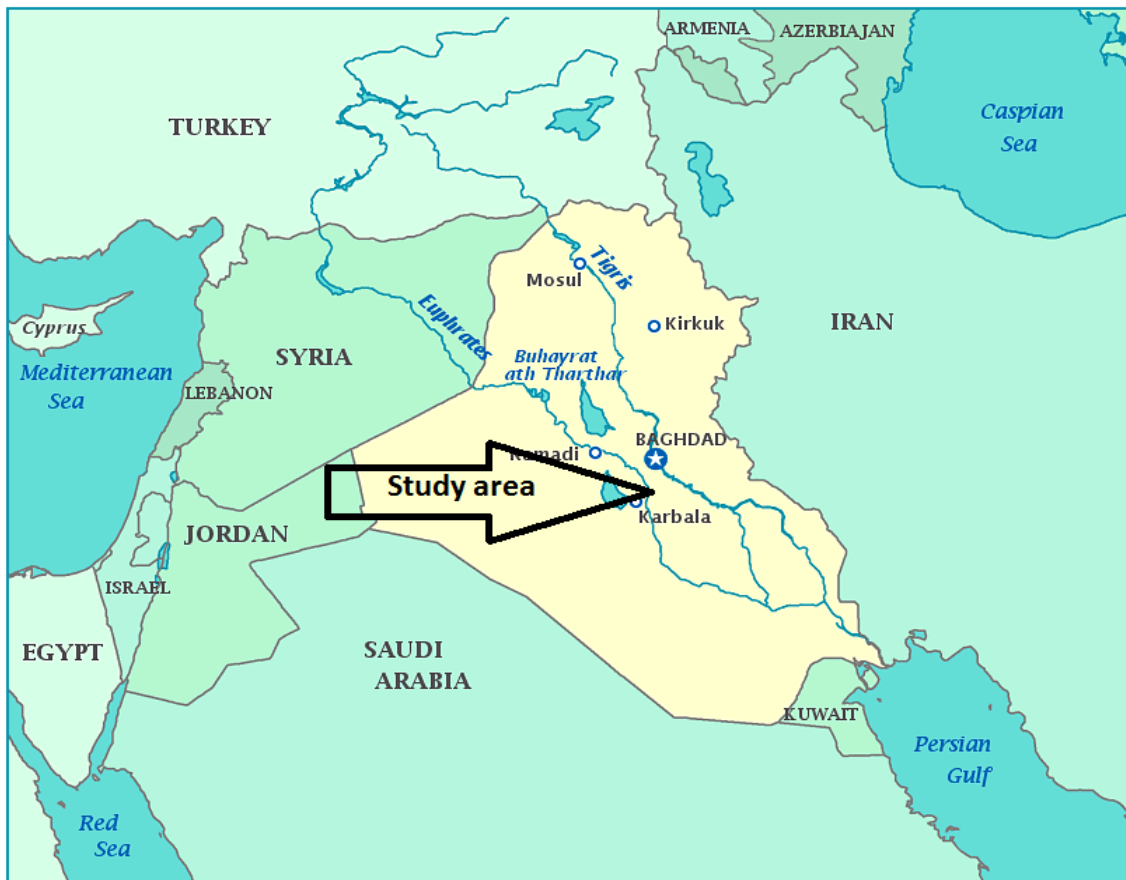

Fig. 1 Study area.

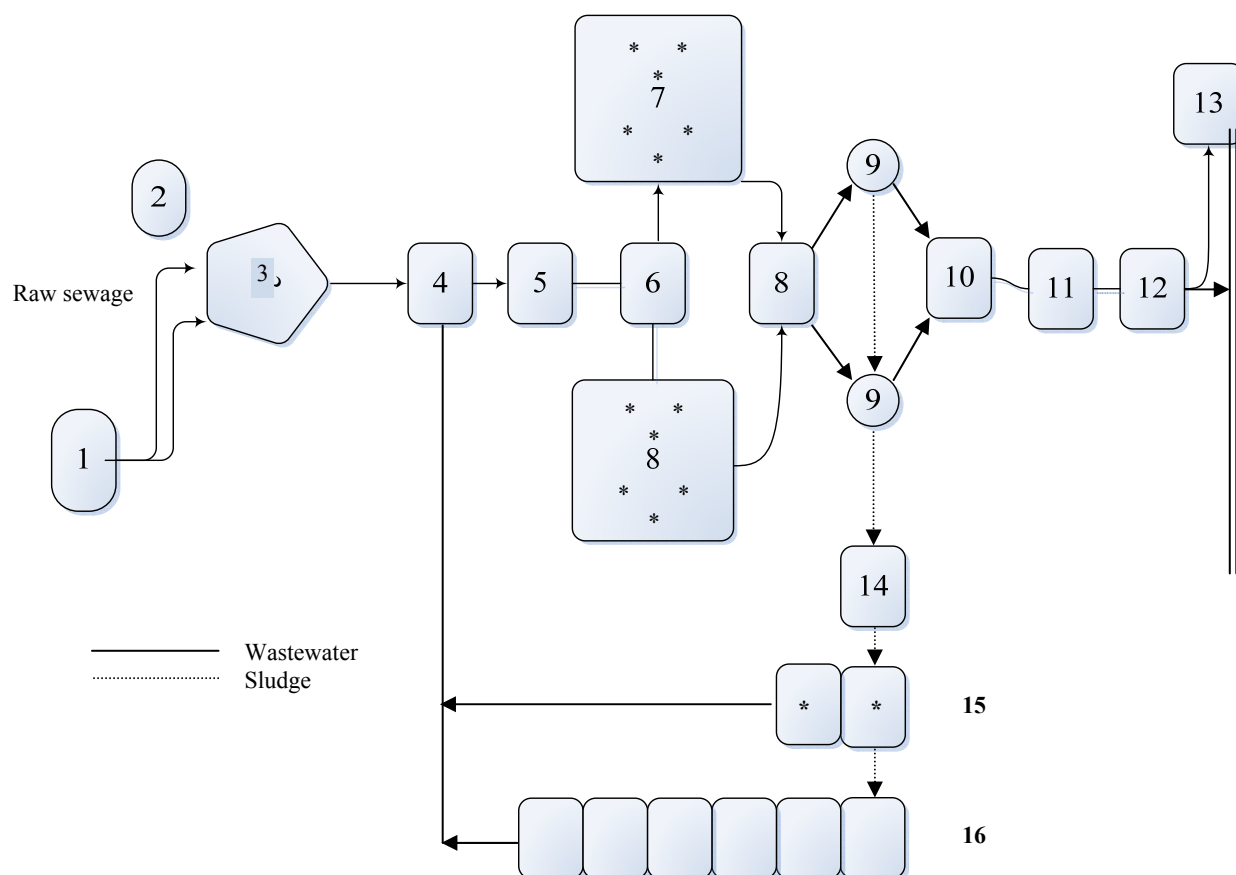

Fig. 2 Flow chart of Al-Hilla WWTP (1: screens; 2: pump; 3: chamber; 4: storage tank; 5: flume; 6: chamber; 7: aeration tank; 8: distribution chamber; 9: settling tank; 10: collection chamber; 11: flume; 12: chlorination unit; 13: outlet; 14: sludge pump; 15: sludge collection tanks; 16: drying bed).

2.2 SimaPro 7 Methodology

SimaPro 7 is a computer software tool used to calculate and identify the pertinent environmental impacts associated with the water treatment plants in this study. It serves as a tool for managing and storing data, making calculations and sensitivity tests. The LCA phases are structured in SimaPro in accordance with ISO14040 and ISO14044 LCA standards [10]. This is the latest version available in Iraq due to the present war situation.

2.2.1 Goal and Scope Definition in SimaPro

A special section is available for a description of the goal and scope for each project. There exist three sections and these include:

(1) Text fields in which a description of the different aspects of the goal and scope definition can be made. Text entered here can be later copied and pasted into

the report [8]. The goals of this study are to analyze and evaluate the environmental impacts of Al-Hilla wastewater treatment plant;

(2) Library section which is possible to predefine which libraries with standard data are considered relevant for the project to be run [8]. For this study, the library of eco-environment system processes was selected;

(3) Data quality data characteristics can be predefined in this section [8].

2.2.2 Inventory Analysis

The inventory analysis, which involved parameters describing material uses and emission to air and water, was quantified in the environmental impacts of 1 m³ of treated wastewater. The assessment covers throughout the entire life cycle of the products or activities.

2.2.3 Unit Process

An important goal of data collection is to establish a database which can be used on an ongoing basis for LCA. The data for a process must be collected in form of the so called normalizing the process (Fig. 3).

2.2.4 Impact Assessment in SimaPro

There exist a wide variety of impact assessment methods available in SimaPro [10]. In this study, The IMPACT 2002+ method was used to determine the environmental impacts of the treatment plant. Fig. 4 shows the overall scheme of the IMPACT 2002+ framework, linking all types of LCA results via the 14 midpoint categories (human toxicity, respiratory effects, ionizing radiation, ozone layer depletion, photochemical oxidation, aquatic ecotoxicity, terrestrial ecotoxicity, terrestrial acidification/nitrification, aquatic acidification, aquatic eutrophication, land occupation, global warming, non-renewable energy and mineral extraction) to the damage categories (human health, ecosystem quality, climate change and resources) [11].

The basic structure of impact assessment methods in SimaPro is characterization, damage assessment, normalization and weighting. The last three steps are optional according to the ISO standards [10].

2.2.5 Interpretations in SimaPro

This is designed as a checklist which covers the relevant issues mentioned in the ISO standards used.

As suggested by Pre Consultants [8], observations are filled in when the LCA study is about to be completed and conclusions made.

3. Results and Discussions

The results of LCA were mostly not straightforward in favor of material design over the alternative one. Results of LCA had to be interpreted or weighted. The IMPACT 2002+ methodology was used and LCA weighting method specially developed for product design. This method had been proven to be a powerful tool for designers to aggregate LCA results into easily understandable and user-friendly numbers or units, the so called IMPACT 2002—impact assessment of chemical toxics.

Fig. 5 shows the global eco-score damage in terms of impact categories for Al-Hilla WWTP. It is noted that the most effective environmental impacts potentially are global warming, respiratory inorganic and non-renewable energy, contributing to the Al-Hilla WWTP. In Al-Hilla WWTP, global warming, respiratory inorganic and non-renewable energy contributed 16.9, 10.5 and 8.42 points, respectively, of total impact 40.6 points.

The damage categories were also analyzed by IMPACT 2002+. Four categories of damage were pointed out: human health, ecosystem quality, climate change and resources (Fig. 6).

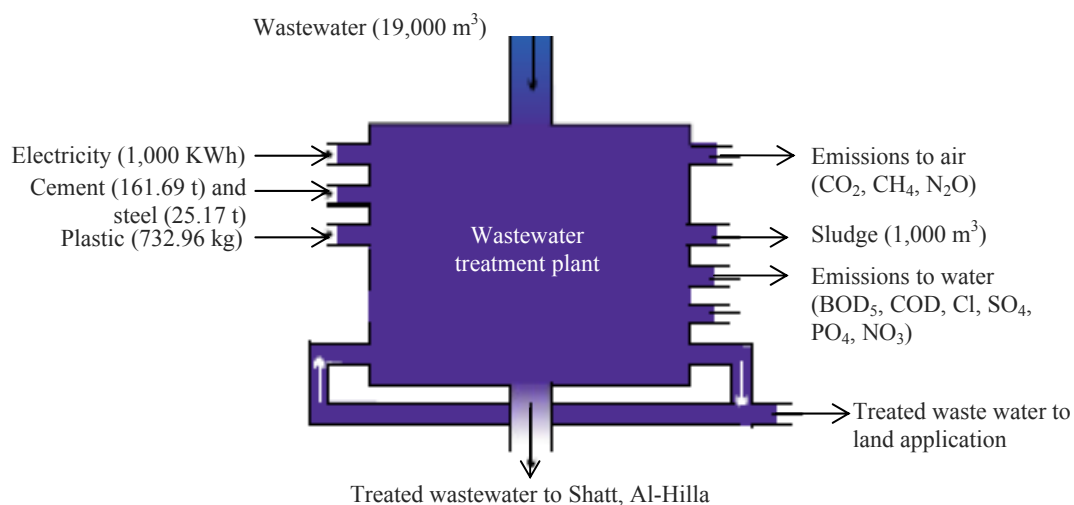

Fig. 3 Inventory analysis of Al-Hilla wastewater treatment plant.

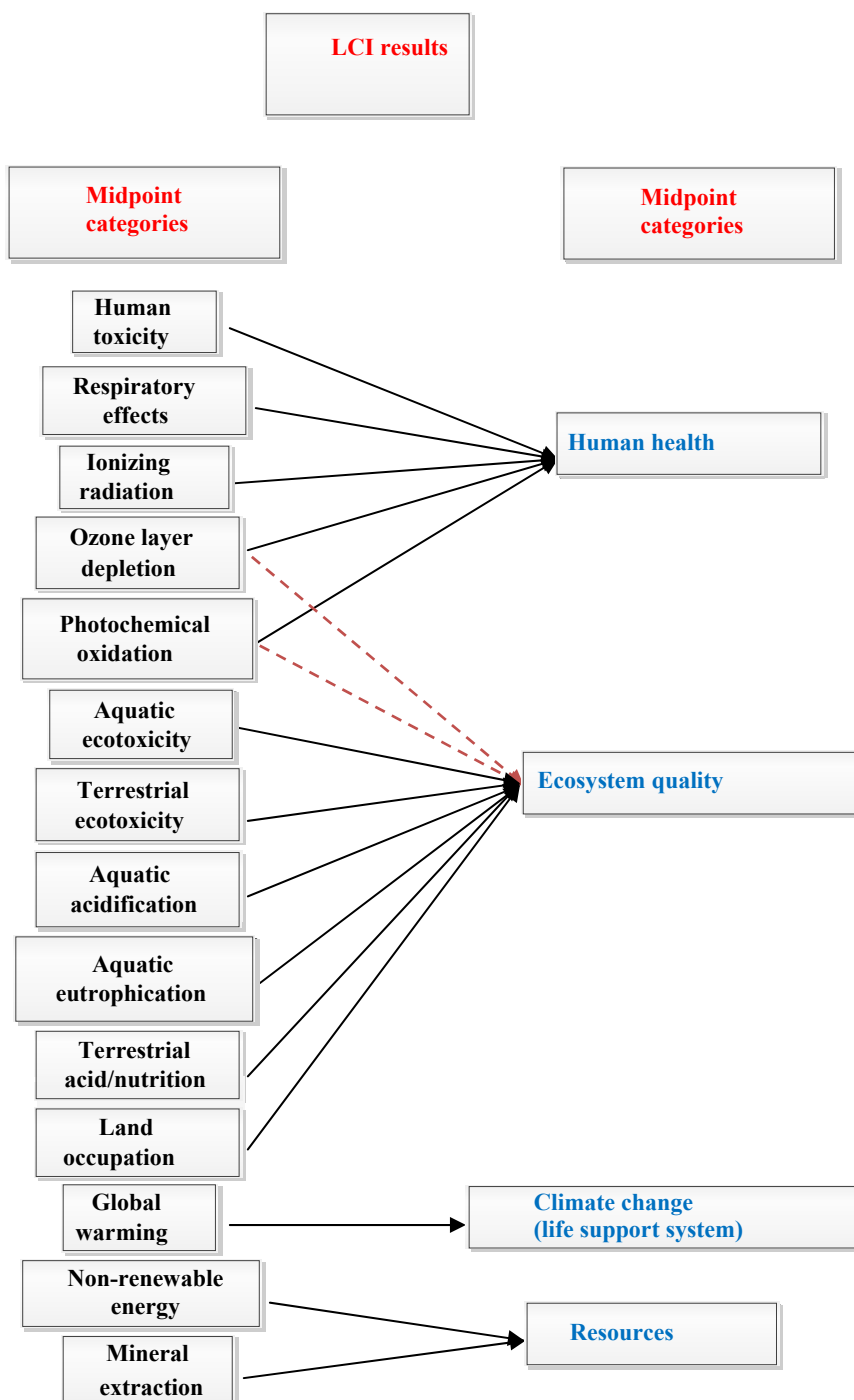

Fig. 4 Overall scheme of the IMPACT 2002+ framework, linking LCI results via the midpoint categories to damage categories [11].

From Fig. 5, it shows that the environmental damages on climate change, human health and resources are much more important relative to the damage on ecosystem quality. In Al-Hilla WWTP, the total damage contributed was 41 points. It can be also

identified that 13.5, 2.14, 16.9 and 8.56 points were contributed to human health, ecosystem quality, climate change and resources, respectively.

It was noted that cement was one of the most processes that contributed several negative effects to

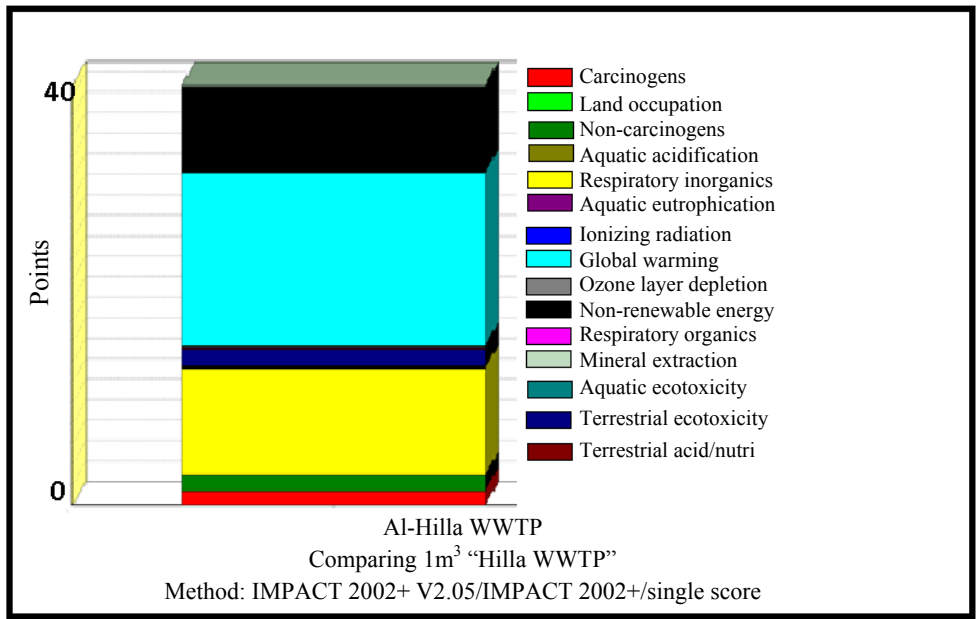

Fig. 5 The global eco-score damage in terms of impact categories.

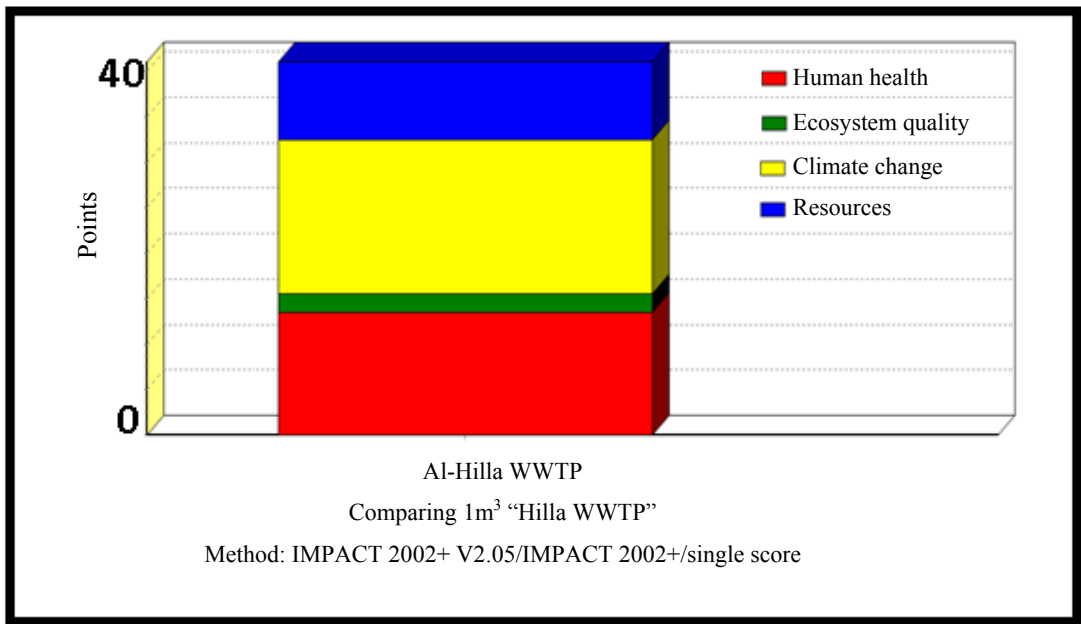

Fig. 6 Global eco-score of damage categories.

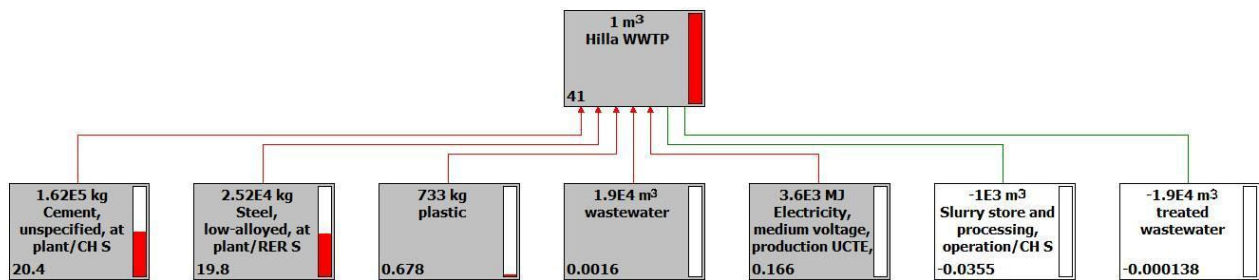

Fig. 7 Processes contributions of Al-Hilla WWTP.

the environment, followed by steel, plastic and then electricity, while the treated wastewater and sludge have positive effects, as described in Fig. 7. The negative sign in this figure refers to that the indicators have positive effects on the environment.

4. Conclusions

The IMPACT 2002+ methods is one of the methods in SimaPro 7 package software, it was applied to evaluate environmental indicators for Al-Hilla WWTP in Al-Hilla City. The results indicated that: the global eco-score on Al-Hilla WWTP was 41 points. The most environmental impact potential were global warming, respiratory inorganics and non-renewable energy, as a result of cement, steel, plastic use during chemical storing and pipes, electricity using for plant operation and emission of the plant.

Furthermore, environmental damage affected human health (13.5 points), climate change (16.9 points), resources (8.56 points) and ecosystem quality (2.14 points).

References

- [1] Al-Ansari, N. A., and Knutsson, S. 2011. "Toward Prudent Management of Water Resources in Iraq." *Journal of Advanced Science and Engineering Research* 1: 53-67.
- [2] Al-Ansari, N. A. 2013. "Management of Water Resources in Iraq: Perspectives and Prognoses." *Journal of Engineering* 5 (8): 667-84.
- [3] Issa, I. E., Al-Ansari, N. A., Sherwany, G., and Knutsson, S. 2014. "Expected Future of Water Resources within Tigris-Euphrates Rivers Basin, Iraq." *Journal of Water Resource and Protection* 6 (5): 421-32.
- [4] Al-Ansari, N. A., Ali, A., and Knutsson, S. 2014. "Present Conditions and Future Challenges of Water Resources Problems in Iraq." *Journal of Water Resources and Protection* 6 (12): 1066-98.
- [5] Al-Ansari, N. A., Ali, A. A., and Knutsson, S. 2015. "Iraq Water Resources Planning: Perspectives and Prognoses." Presented at ICCCE 2015: XIII International Conference on Civil and Construction Engineering, Jeddah, Saudi Arabia.
- [6] Amores, M. J., Meneses, M., Pasqualino, J., Antón, A., and Castells, F. 2013. "Environmental Assessment of Urban Water Cycle on Mediterranean Conditions by LCA Approach." *Journal of Cleaner Production* 43: 84-92.
- [7] Altaee, S. A. 2013. "Comparison Study for Appraisals of Environmental Sustainability Indicators Wastewater Treatment Plants for Middle Euphrates Region in Iraq." M.Sc. thesis, University of Babylon.
- [8] PRé Consultants. 2013. "Introduction to LCA with SimaPro 7." PRé Consultants. Accessed April 15, 2015. <http://www.pre-sustainability.com/download/SimaPro8IntroductionToLCA.pdf>.
- [9] Babylon Census Directorate. 2013. *Records*. Iraq: Babylon Governorate.
- [10] Akwo, N. S. 2008. "A Life Cycle Assessment of Sewage Sludge Treatment Options ." M.Sc. thesis, Aalborg University.
- [11] Rolf, F., and Niels, J. 2007. "Implementation of Life Cycle Assessment Methods." Swiss Centre for Life Cycle Inventories. Accessed April 15, 2015. <http://www.pre-sustainability.com/download/manuals/EnvironmentOverviewAndMethodology.pdf>.